

THIS DRAWING CONTAINS INFORMATION PROPRIETARY TO RF INDUSTRIES.
 ANY UNAUTHORIZED USE OF THIS DRAWING IS EXPRESSLY PROHIBITED
 WITHOUT WRITTEN PERMISSION FROM RF INDUSTRIES.
 ANY VIOLATION IS PUNISHABLE UNDER U.S. COPYRIGHT LAWS.

ALL DIMENSIONS ARE REFERENCE ONLY

PART NO.		RFN-1025-1		
REV	DESCRIPTION	DWN	DATE	APPROVED
A	ENGINEERING RELEASE	CZS	6/26/98	R. RICE
B	UPDATE DWG. DIMS & SPECS / CHG. DWG. # 8931	GGG	2/19/02	JDMc

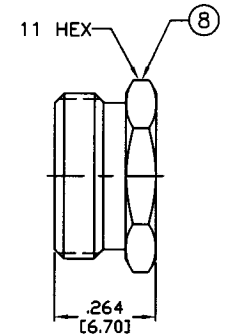
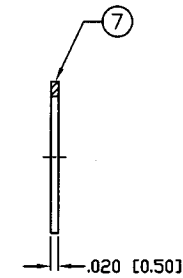
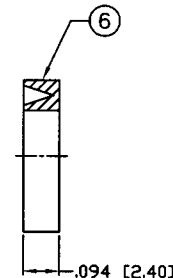
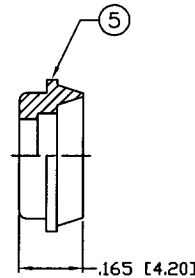
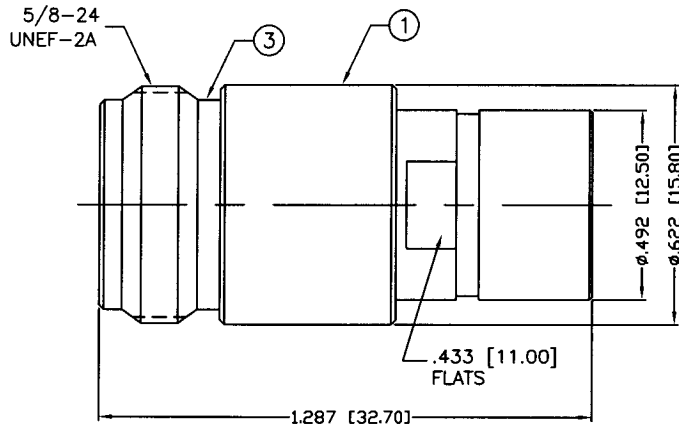

SPECIFICATIONS:

IMPEDANCE: 50 Ohms
 FREQUENCY RANGE: 0-11 GHz
 VSWR: 1.3 Max.
 INSERTION LOSS: .06 dB Max. $X\sqrt{fGHZ}$
 WORKING VOLTAGE: 1k V rms @ sea level
 TEMPERATURE RANGE: -65°C TO 85°C
 INSULATION RESISTANCE: 5k M Ohms min.
 FOR RG-58, 58A, 58C, 141, 141A, BELDEN 8240,
 8262, 9201, 9203, 9310, 9311 & COMM/SCOPE 0268

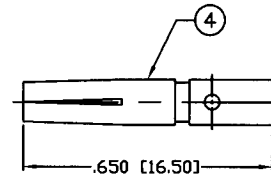

CONTACT TO BE SOLDER

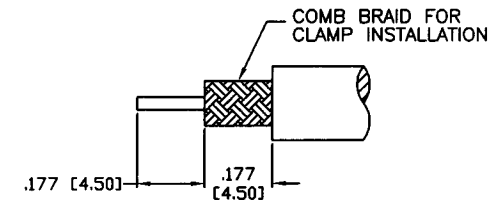

RECOMMENDED STRIPPING DIMENSIONS

1	BODY	1	BRASS	SILVER, 80μ"	008974	
2	INSULATOR	1	PTFE	---		
3	PRESS BODY	1	BRASS	SILVER, 80μ"		
4	CONTACT	1	PHOS BRONZE	GOLD, 3μ"		
5	CLAMP	1	BRASS	SILVER, 80μ"		
6	GASKET	1	SILICONE	---		
7	WASHER	1	BRASS	SILVER, 80μ"		
8	HEX NUT	1	BRASS	SILVER, 80μ"		
9						
10					DRAWN	
11					G. GALLEGOS	
12					CHECKED	
13					2/19/02	
14					ORJ DRAWN	
					C. ZUNIGA	
					6/26/98	
#	DESCRIPTION	QTY	MATERIAL	FINISH	APPROVALS	DATE

UNLESS OTHERWISE SPECIFIED:
 1. REMOVE ALL BURRS
 2. BREAK ALL CORNERS & EDGES .005 R. MAX.
 3. CHAMFER 1ST & LAST THREADS 45°
 4. SURFACE ROUGHNESS 63 FINISH MIL-STD-10
 5. DIAMETERS ON COMMON CENTERS TO BE CONCENTRIC WITHIN .002 T.I.R.
 6. ALL DIMENSIONS ARE AFTER PLATING.

DIMENSIONS ARE IN INCHES AND [MILLIMETERS]
 UNLESS OTHERWISE NOTED TOLERANCES ARE:
 DECIMALS DIAMETER
 .xxx±.003 [.08] .xxx±.001 [.03]
 .xx±.005 [.13] .xx±.003 [.08]

RF connectors
 DIVISION OF RF INDUSTRIES, LTD.
 7610 MIRAMAR RD
 SAN DIEGO, CA 92126
 (858) 549-6340
 (858) 549-6345 FAX

N JACK CLAMP

SIZE	CABLE GROUP	DWG NO.	REV
A	C	RFN-1025-1	B
SCALE: NTS		CAD FILE OUTLINE	SHEET 1 OF 1